



ED 100

ED 250

## Table of contents

	Page
1. General overview.....	2
1.1 Terminal assignment .....	2
1.2 Terminal assignment, Barrier-Free WC.....	3
2. BEA IRS-4 / 4-Safe.....	4
3. BEA FlatScan.....	5
4. Prosecure OPTISAFE.....	6
5. Electric strike, pass system and elbow switch.....	7
6. Accessories.....	8
7. Barrier-Free toilet accessory.....	9
8. DCW key- and program switch.....	10
9. BRC integrated receiver.....	11
10. Swedish Fire card.....	12

# 1. General overview

Connect the connecting cables to the connector and insert the connector into the connection board.

- Maximum 1.5 A total load on the terminals 1, 1G and 3.
- Cable length maximum 30 m for J-Y(ST)Y 0.8 mm

## 1.1 Terminal assignment

- 1 The terminal is included in the scope of delivery of the Upgrade Card DCW.
- 2 The terminal is included in the scope of delivery of the Upgrade Card Fire Protection. If the Upgrade Card Fire Protection is installed, you must connect either an RM-ED or the load resistor 18 k.

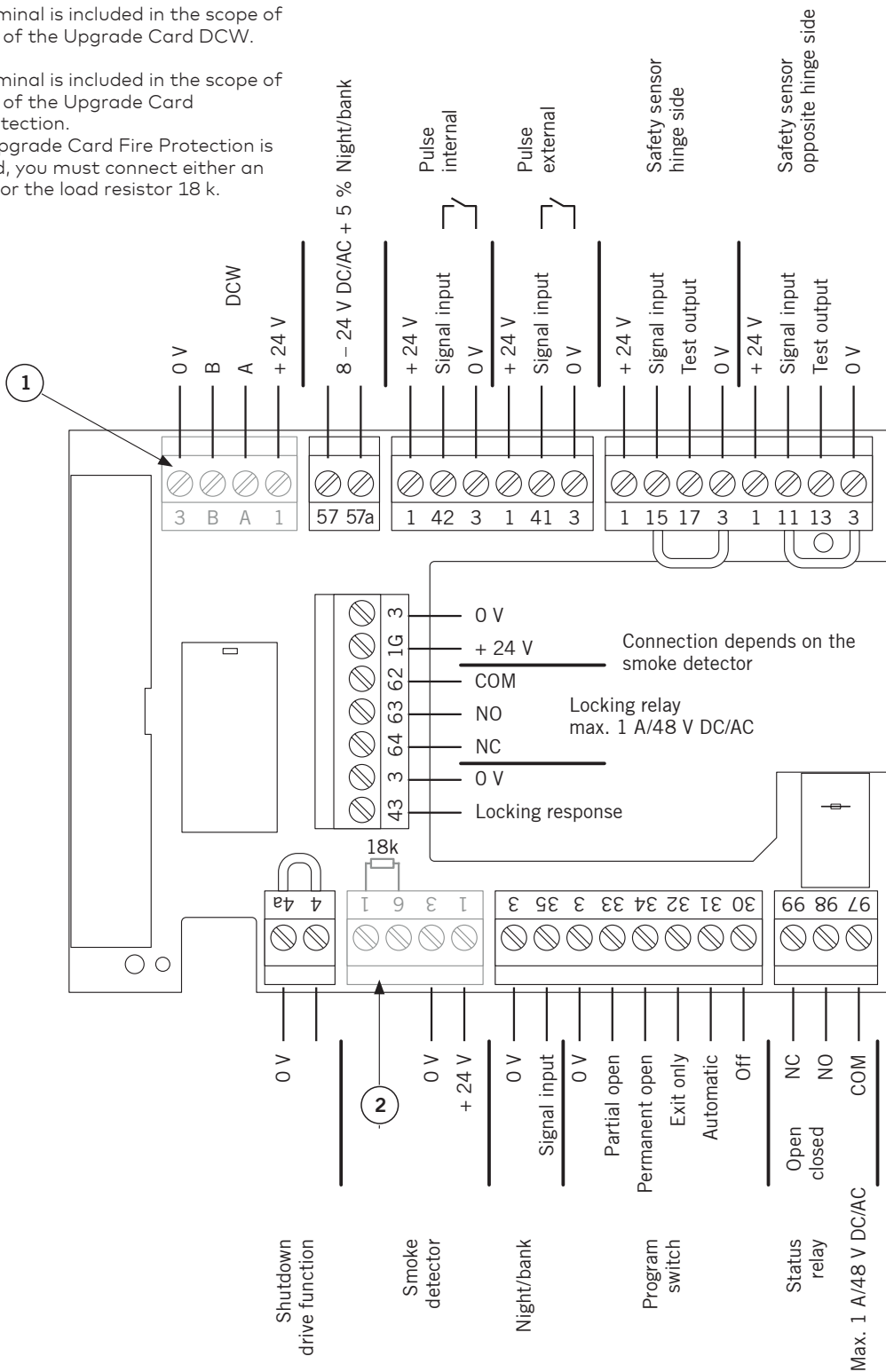

### 1.2 Terminal assignment for an Upgrade Card barrier-free WC

The door system must be equipped with the following components:

- Electric strike
- On the inside with a door handle and a knob on the outside
- Flat pushbutton on the inside and outside
- On the outside: a status display "free/occupied"
- On the inside: a status display "occupied"

Emergency buttons can be installed optionally on the inside and outside. dormakaba recommends to include the barrier-free WC into an emergency call system provided by the customer.

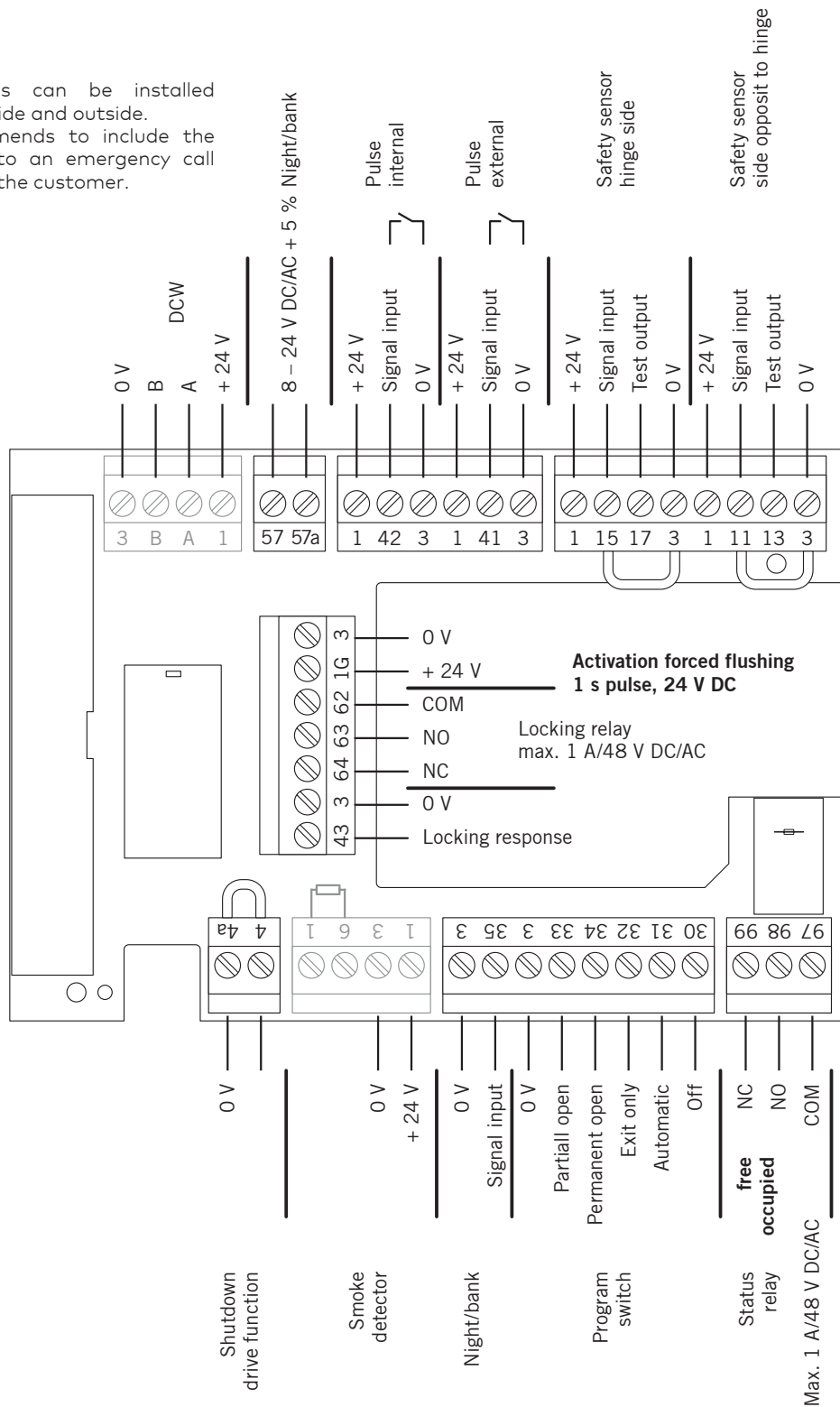

## 2. BEA IRS-4 / 4-Safe

Test Safety sensor 	0 – 6	<b>0</b>	Test off. The safety sensors will not be tested. To be used with the safety sensor IRS-2. In combination with safety sensors according to EN 16005 or DIN 18650, one of the parameters 1 – 6 must be used. The test level Low and High active depends on the sensor and must be set on the sensor to the same value as the drive unit.
		1	Test sensor BS - Level High active
		2	Test sensor BGS - Level High active
		3	Test sensor BS & sensor BGS - Level High active
		<b>4</b>	<b>Test sensor BS - Level Low active</b>
		5	Test sensor BGS - Level Low active
		6	Test sensor BS & sensor BGS - Level Low active

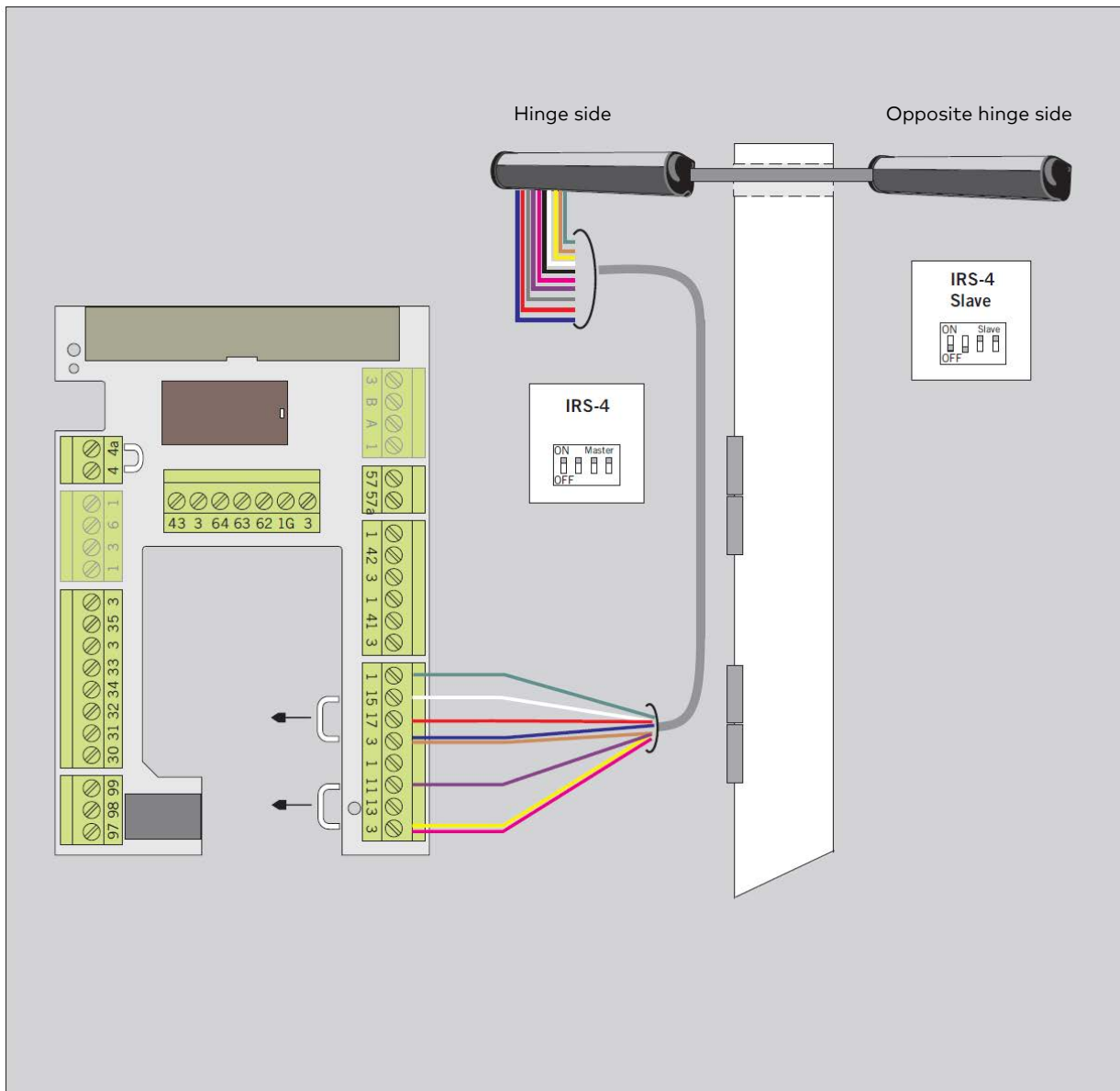

### 3. BEA FlatScan

Test Safety sensor 	0 – 6	<b>0</b>	Test off. The safety sensors will not be tested. To be used with the safety sensor IRS-2. In combination with safety sensors according to EN 16005 or DIN 18650, one of the parameters 1 – 6 must be used. The test level Low and High active depends on the sensor and must be set on the sensor to the same value as the drive unit.
		1	Test sensor BS - Level High active
		2	Test sensor BGS - Level High active
		3	Test sensor BS & sensor BGS - Level High active
		4	Test sensor BS - Level Low active
		5	Test sensor BGS - Level Low active
		<b>6</b>	<b>Test sensor BS &amp; sensor BGS - Level Low active</b>

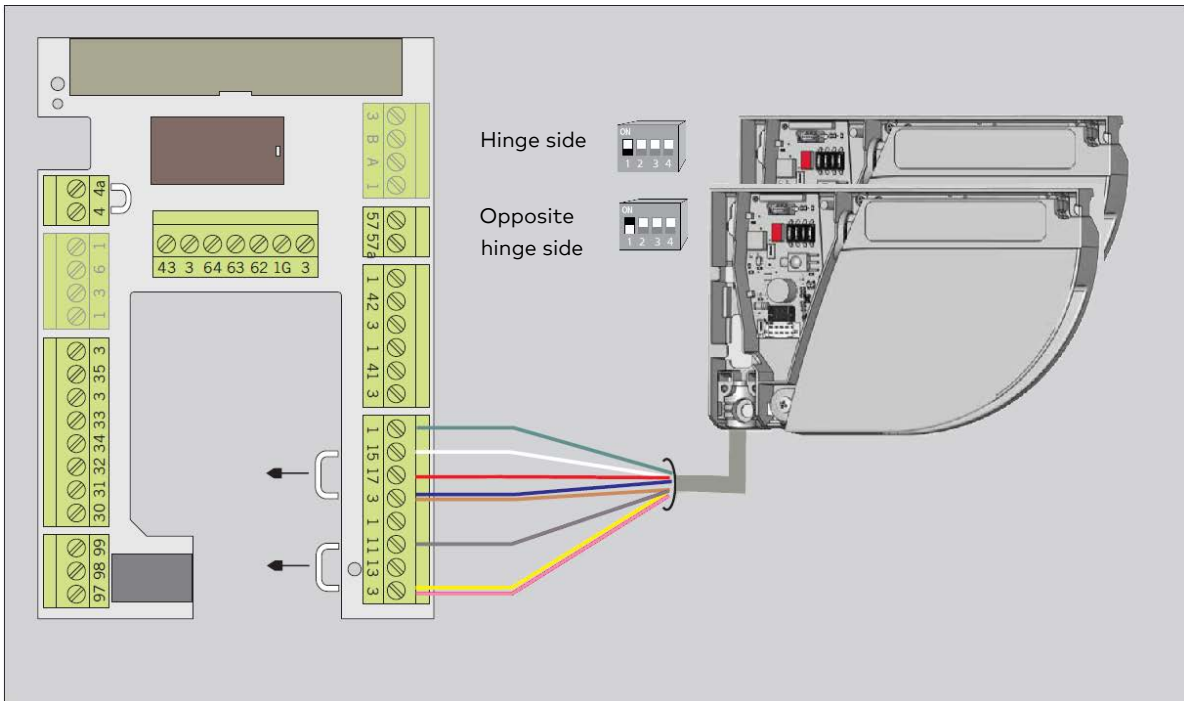

## 4. Prosecure OPTISAFE

Hold the green button for 5 seconds until the red and green LED lights up.  
 Let the sensing field be undisturbed for 15 seconds. When both LED lights are turned off, the sensor is ready.  
 Check the function of the safety sensors by placing objects under them.

Program the following parameters:

- ED100/250 parameter  6
- Safety sensor parameter "1" 4

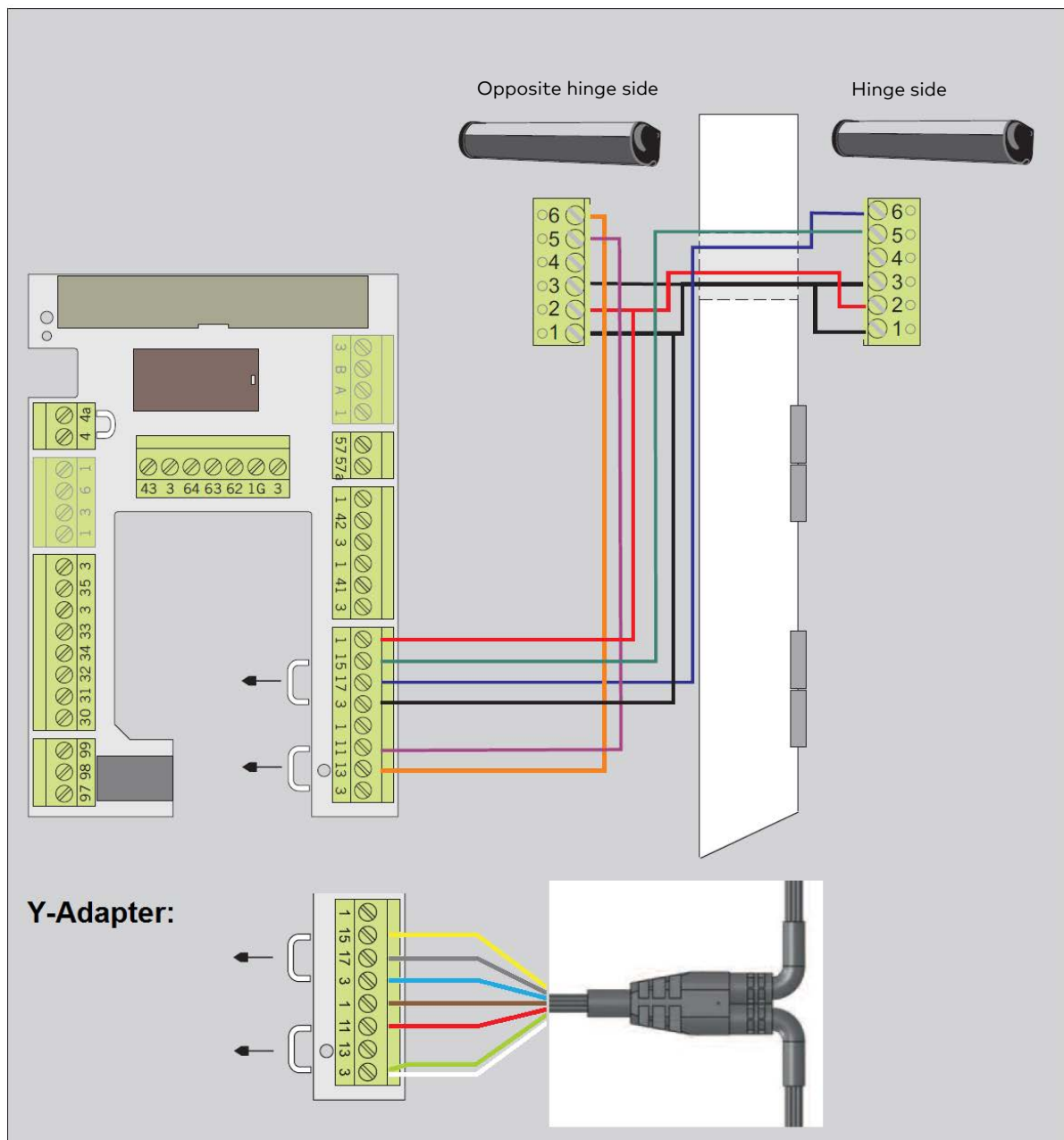





## 5. Electric strike, pass system and elbow switch

### Function:

When the key switch/code lock is **not activated**, the ED operator is in EXIT mode and only inside impulse works. When the key switch/code lock is **activated**, the ED operator changes to AUTOMATIC mode and opens the lock - now outside impulse/elbow switch is also working.

Potential-free pulse from the inner elbow switch is connected to the terminal 3-42 and outside to the terminal 3-41. Electrical strike opens via lock relay, outputs 1G and 3. Switch/code lock is connected to the program switch connector.

Program the following parameters:

- Unlocking force  0 - 9
- Hold-Open time  0 - 30
- Program switch type  1
- Day activation  1

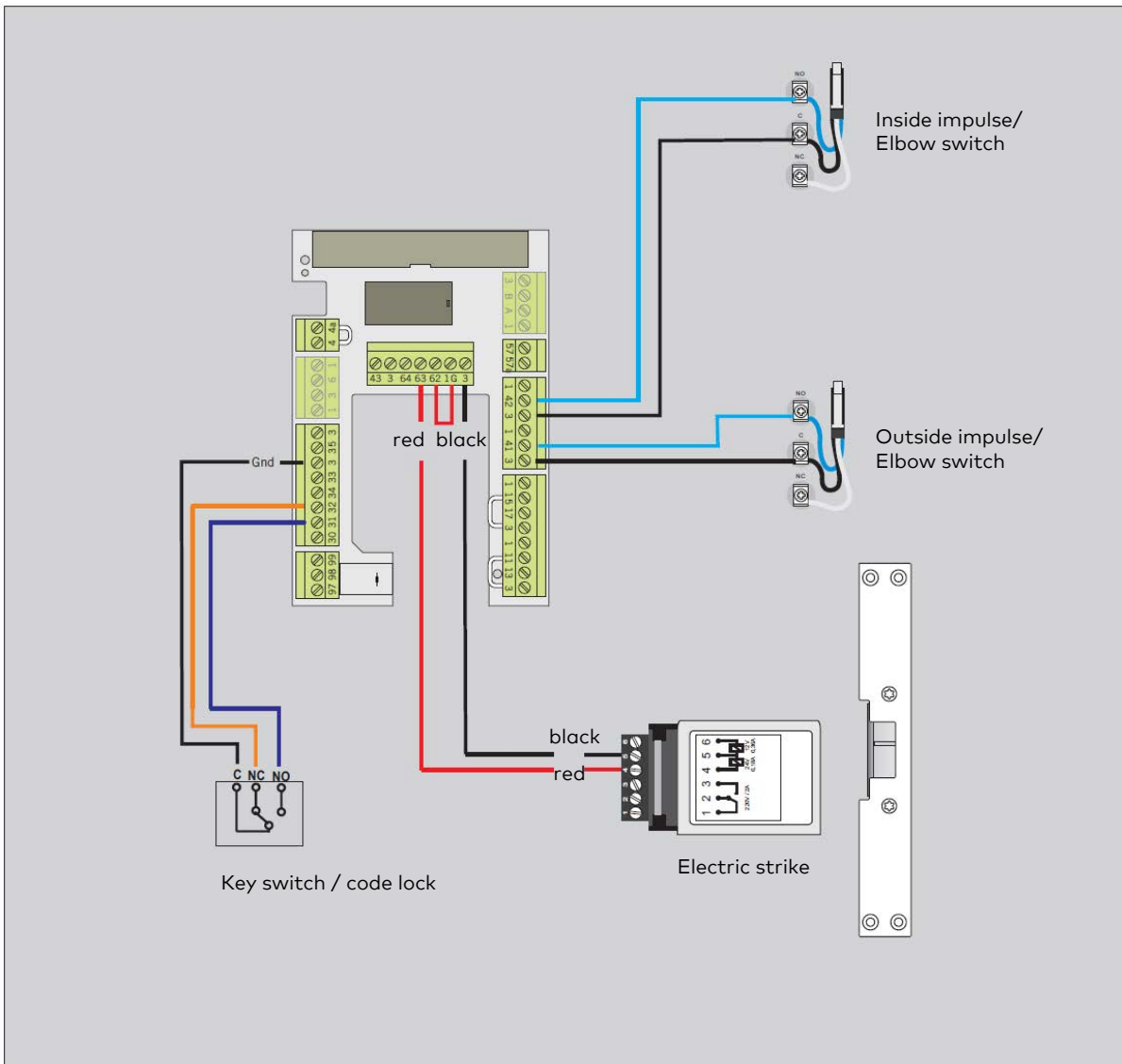



## 6. Accessories

### Key switch Input

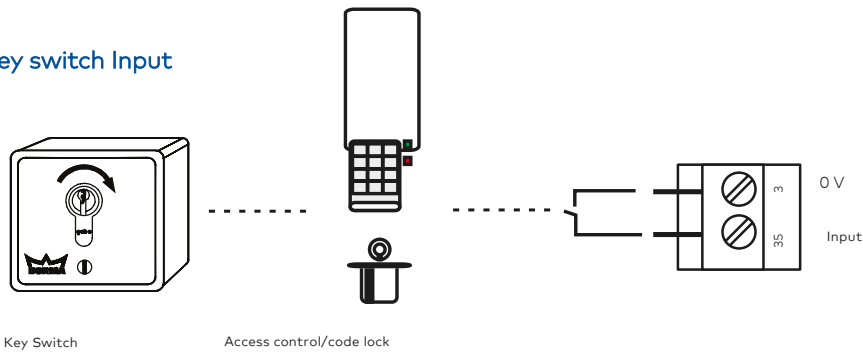

### External program switch

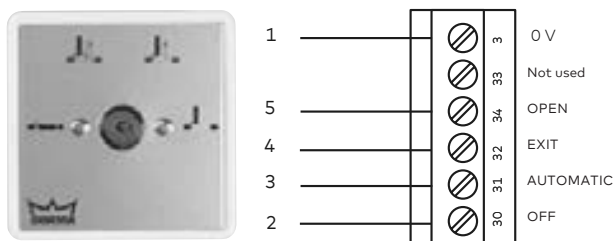

### Radars and elbow switches

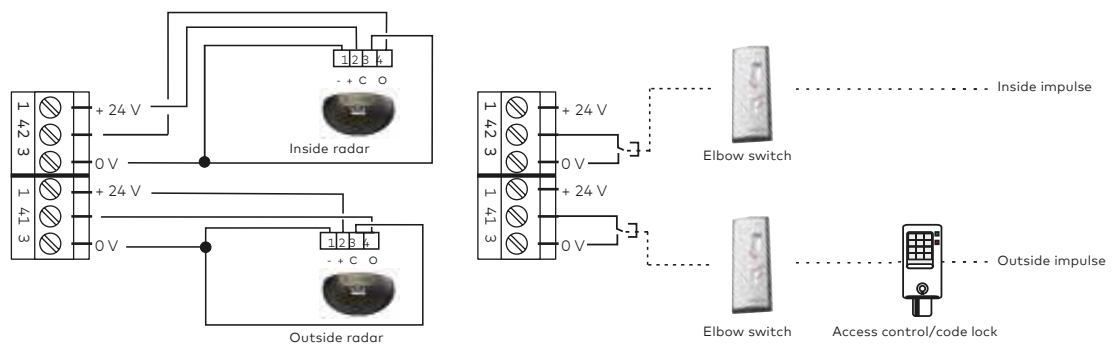

## 7. Barrier-Free toilet accessory

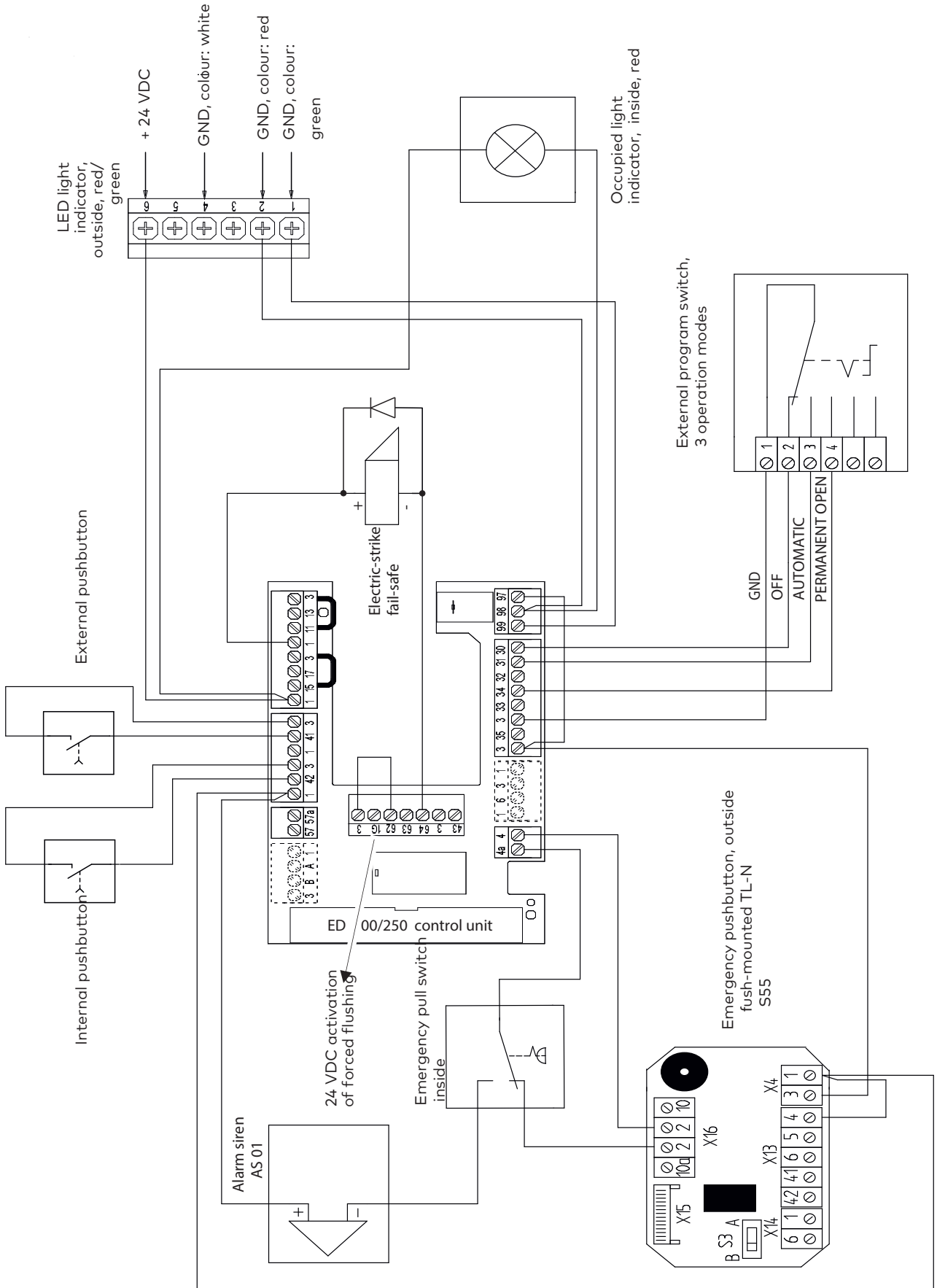

## 8. DCW key- and program switch

Upgrade card DCW, article number 29254001

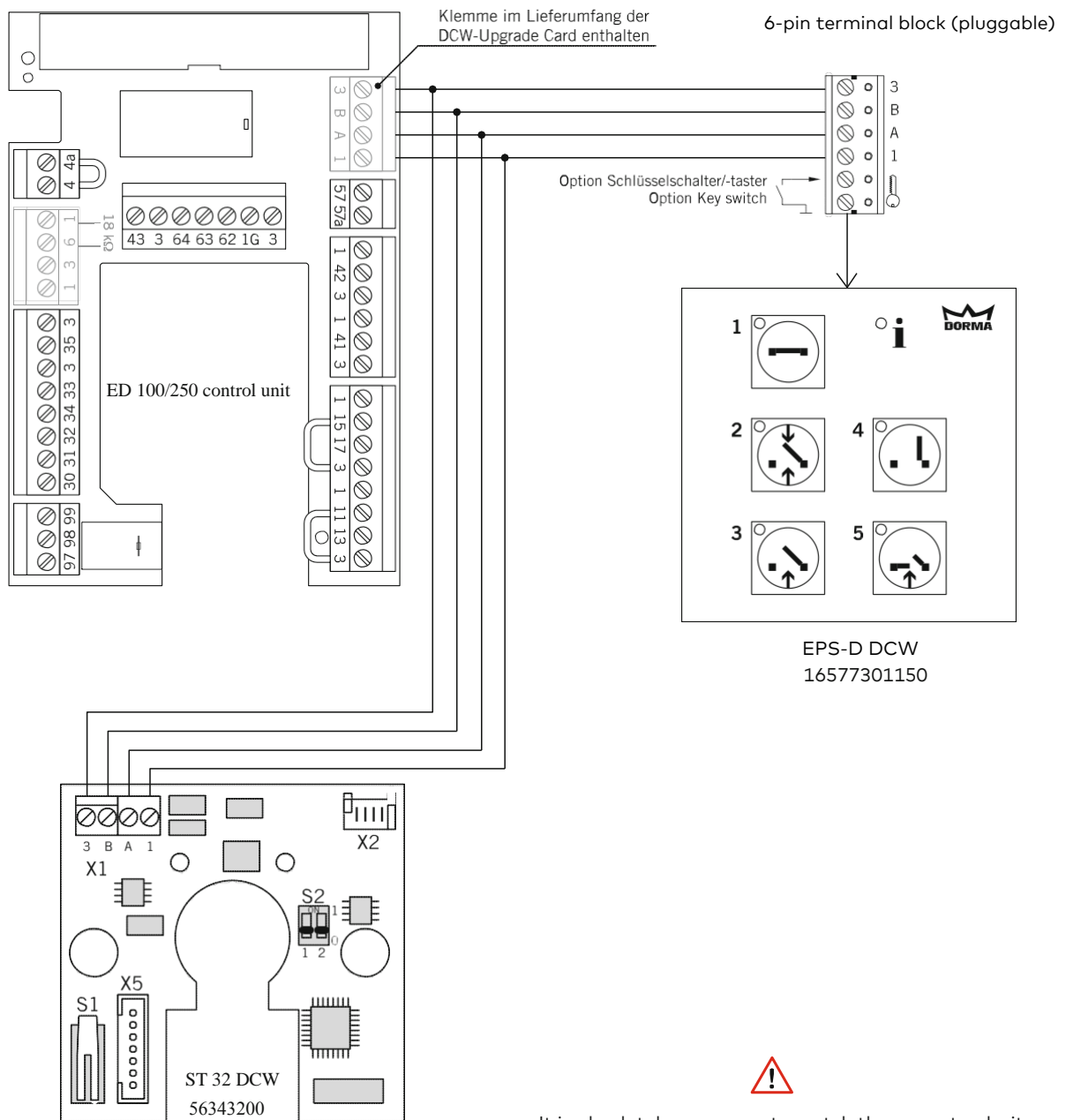

It is absolutely necessary to watch the correct polarity when connecting the program switch to the control-unit! Otherwise the control-unit and the program switch may be destroyed.

## 9. BRC integrated receiver

### Programming the receiver

Keep the teach button of the receiver pressed for 4 seconds.  
 Red LED starts to blink slowly and the receiver is ready to receive information from the transmitter.  
 Press the teach button of the transmitter within 20 seconds.  
 Press the normal activation switch/channel of the transmitter.

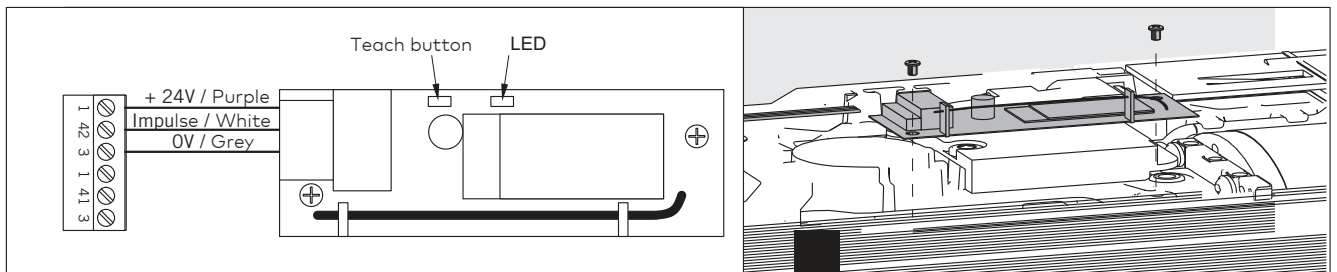

### Wall transmitter

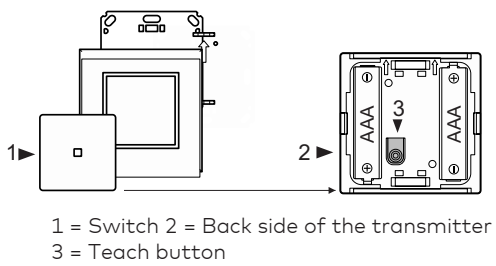

### Hand transmitter

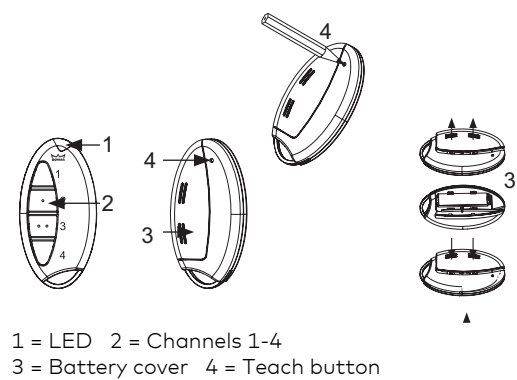

### Transmitter for elbow switches

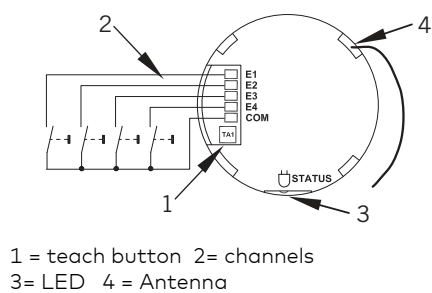

## 10. Swedish Fire card - Optisafe safety sensor

### Function

Safety sensors are switched off by fire alarm to prevent door being kept open by smoke.



With this connection, the safety regulations of EN 16005 standard are not fulfilled.

### Installation

Hold the green button in the safety sensors for 5 s until red and green LED are lit.

Let the sensing field be undisturbed for 15 seconds. When both LEDs are turned off, the sensor is ready. Test that the sensors are working.

Program the following parameters:

- ED100/250 parameter  **3**
- Safety sensor parameter "1" **2**

